

USER RESTRICTED TO 18 YEARS OF AGE OR OLDER

ARES MG-006



Automatic Electric Airsoft Gun Instruction Manual • Always read through this manual before operation



THE REPLACEMENT PARTS WILL BE AVAILABLE AT OURS LOCAL DISTRIBUTOR AND DEALERS

INSERT BATTERY

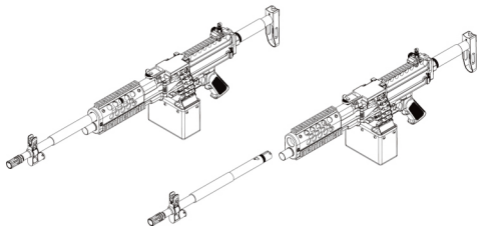

SETTING THE MAGAZINE

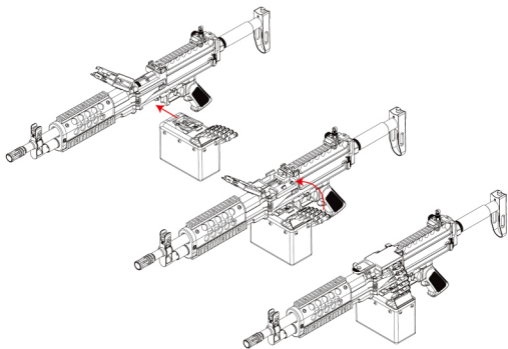

FIRING MODE

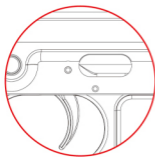
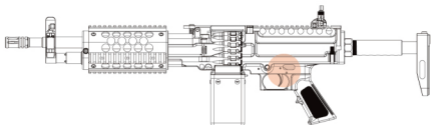

SAFETY



FIRE

HOP UP ADJUSTMENT

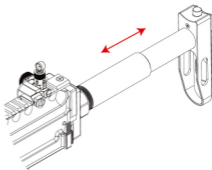
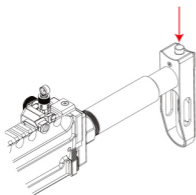

THE REPLACEMENT PARTS WILL BE AVAILABLE AT OURS LOCAL DISTRIBUTOR AND DEALERS

HOP-UP ADJUSTMENT

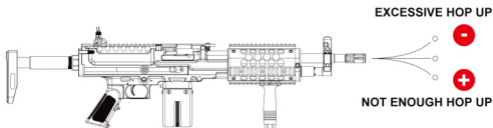
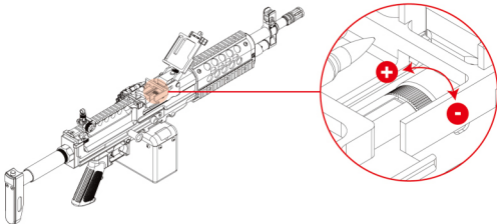

QUICK CHANGE SPRING

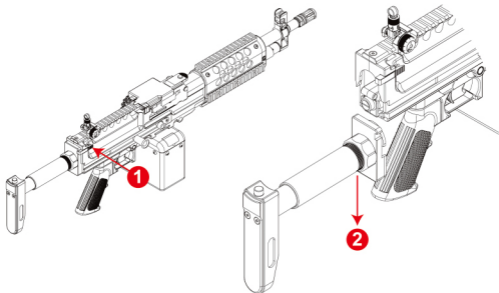

DATA OF ARES MG-006 ELECTRIC GUN

MG-006



FEATURES

- Full Metal Construction
- Direct-Feed Box Magazine Feeding System
- Hand-Tuned Metal Gearbox
- Quick Change Spring System
- Tight Bore Barrel
- 6 Position Collapsible Stock

BATTERY:	9.6V 1500mAh mini (2/3A) (Box Mag)
MAGAZINE CAPACITY:	500rds (6mm BB, Box Mag)
MODE:	Full Auto
MATERIAL:	Nylon Fiber + Al.Alloy
MOTOR:	High Torque Flat Motor
HOP-UP:	Adjustable
LENGTH:	790-920mm (Stock Extend)
WEIGHT:	3400g
VELOCITY:	350-380FP



FOR MORE DETAIL INFORMATION PLEASE VISIT OUR WEBSITE

DATA OF ARES LSW-001 ELECTRIC GUN

LSW-001



FEATURES

- Full Steel Body
- Easy Spring Release
- Folding Bipod

BATTERY:	8.4V 1500mAH Mini (2/3A) Nunchuck
MAGAZINE CAPACITY:	130rds (6mm BB)
MODE:	Full Auto / Semi / Safe
MATERIAL:	Nylon Fiber + Steel
MOTOR:	High Torque Flat Motor
HOP-UP:	Adjustable
LENGTH:	920mm
WEIGHT:	5600g
VELOCITY:	350-380FPS



Manufacturer & Brand Owner : Forever Good (Hong Kong) Ltd.

ARES[®]



SHOOTER



Worldwide:

Ares Website: <http://www.aresairsoft.com>

General Enquiries: ares@aresairsoft.com

North America: ZShot

Exclusive Distributor - <http://www.ZShot.com>

Dealer Inquires: Sales@ZShot.com Technical Support: Support@ZShot.com